

# EUROHM

*Resistive Products*



# Anglia

# Eurohm Resistive Products

## Contents

**Click on the links below to go to the relevant page**

Thick Film Chip Resistors	2-3
Metal Film Resistors	4-5
Fusible ¼ Watt Resistors	6
Carbon Film Resistors	7-8
Wirewound, 2.5 Watt Resistors	9
Metal Oxide, 3 Watt Resistors	10
Chip Resistor Array	11-12

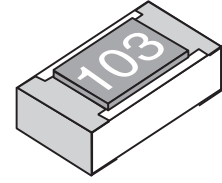

A range of surface mount resistors with industry standard chip sizes.

Features :

- Meets JIS specification
- High performance and reliability
- Nickel barrier terminations
- Suitable for wave and reflow soldering
- Zero-ohm available

Type	SMR63	SMR85	SMR126
Size Code	0603	0805	1206
Power Dissipation at 70°C	0.063W	0.125W	0.25W
Working Voltage	50V	150V	200V
Overload Voltage	100V	300V	400V
Zero Ohm			
Resistance	50mΩ	50mΩ	50mΩ
Current Rating	1A	2A	2A
Peak Current	3A	10A	10A
Body Marking	3 Digit resistance code	2 & 5% : 3 Digit resistance code 1% : 4 Digit resistance code	2 & 5% : 3 Digit resistance code 1% : 4 Digit resistance code

### MARKING

Each resistor is marked with a three or four digit code to designate the nominal resistance value.

#### 3 - Digit marking

For values upto 91 Ω the R is used as a decimal point. For values of 100 Ω or greater the first 2 digits are significant, the third indicates the number of zeros to follow.

#### 4 - Digit marking

For values upto 988 Ω the R is used as a decimal point. For values of 1kΩ or greater the first 3 digits are significant, the fourth indicates the number of zeros to follow.

#### Zero-ohm

This has an unmarked blue coating.

### CONSTRUCTION

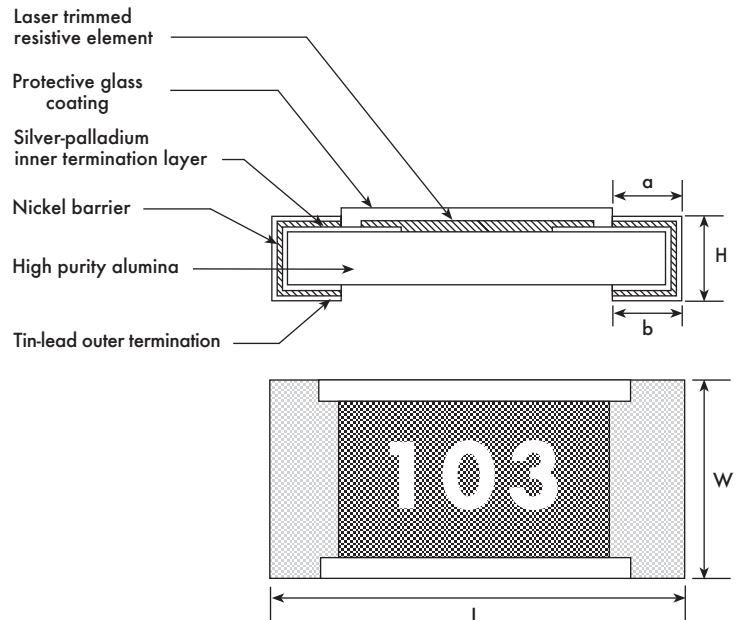

Chip Size	L	W	H	a	b
0603	1.60 ±0.10	0.80 ±0.10	0.45 ±0.10	0.30 ±0.20	0.30 ±0.20
0805	2.00 ±0.10	1.20 ±0.15	0.55 ±0.10	0.40 ±0.20	0.40 ±0.20
1206	3.10 ±0.10	1.60 ±0.15	0.55 ±0.10	0.50 ±0.25	0.50 ±0.25

GENERAL SPECIFICATION		Test Method	ALL CHIP SIZES		
Resistance Tolerance	JIS-C-5202 5.1	1%	2%	5%	
Resistance Range		10R to 1M0 (E24)	10R to 1M0 (E24)	1R0 to 10M (E24)	
Temperature Coefficient	JIS-C-5202 5.2	± 100 ppm/°C	± 200 ppm/°C	± 200 ppm/°C	
Solderability	JIS-C-5202 6.5	Over 95% termination coverage	Over 95% termination coverage	Over 95% termination coverage	
Insulation Resistance	JIS-C-5202 5.6	1000MΩ	1000MΩ	1000MΩ	
Operating Temperature Range		-55°C to +125°C	-55°C to +125°C	-55°C to +125°C	
Performance					
Short term overload	JIS-C-5202 5.5	±(1%+0.05R)	±(2%+0.1R)	±(2%+0.1R)	
Terminal Strength	JIS-C-5202 6.1	±(1%+0.1R)	±(1%+0.1R)	±(1%+0.1R)	
Temperature cycling	JIS-C-5202 7.4	±(0.5%+0.05R)	±(1%+0.1R)	±(1%+0.1R)	
Soldering Heat	JIS-C-5202 6.4	±(0.5%+0.05R)	±(1%+0.1R)	±(1%+0.1R)	
Damp Heat (1000 hrs)	JIS-C-5202 7.9	±(1%+0.1R)	±(3%+0.1R)	±(3%+0.1R)	
Endurance (1000 hrs)	JIS-C-5202 7.1	±(1%+0.1R)	±(3%+0.1R)	±(3%+0.1R)	

### DERATING CURVE

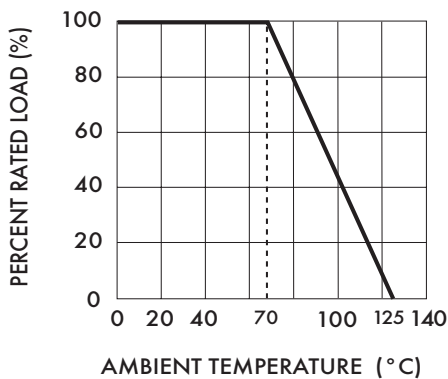

### P.C.B. PAD PATTERN

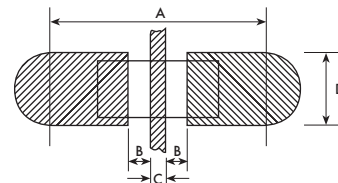

	A	B	C	D
0603	2.7	0.3	0.2	0.52~0.92
0805	3.5	0.3~0.4	0.3	1.1~1.3
1206	5.0	0.8	0.6	1.4~1.8

## PACKAGING

### TAPE

Material : Paper

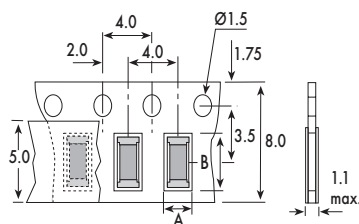

	0603	0805	1206
A	1.1	1.65	2.0
B	1.9	2.4	3.5

### REEL

Material : Plastic  
Quantity : 5000pcs (standard)

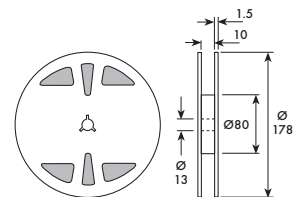

Larger reels (330mm dia.) containing 20K pcs are available to special factory order.

A range of high quality resistors using superior metal film technology.

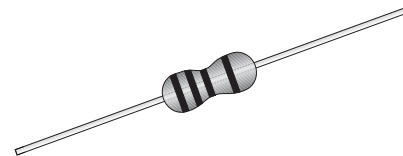

**Features :**

- High stability and reliability
- Low noise
- 4 band colour code

SPECIFICATION	MCR25	MF25	MF40	MF60
Meets	EIA-RS-196A JIS-C-6402 IEC 115-1	DIN 44061 style 0207 MIL-R-10509 style RN55	MIL-R-10509 style RN50	MIL-R-10509 style RN55
Power Dissipation at 70°C	0.25W	0.25W	0.4W	0.6W
Resistance Tolerance	±2%, ±5%	±1%	±1%	±1%
Resistance Range	1R0 to 10M (E24)	1R0 to 10M (E24)	10R to 1M0 (E24)	1R0 to 10M (E24)*
Working Voltage	250V	250V	200V	250V
Overload Voltage	500V	500V	400V	500V
Temperature Coefficient	±100ppm/°C (2%) ±200ppm/°C (5%)	±50ppm/°C	±50ppm/°C	±50ppm/°C
Operating Temperature Range	-55 °C to +155 °C			
Current Noise	0.01µV/V for values up to 1K0 rising to 0.5µV/V on highest values			
Performance				
Short term overload	±(0.5% +0.05R)	±(0.25% +0.05R)	±(0.5% +0.05R)	±(0.5% +0.05R)
Vibration	±(0.5% +0.05R)	±(0.25% +0.05R)	±(0.5% +0.05R)	±(0.5% +0.05R)
Temperature cycling	±(0.5% +0.05R)	±(0.25% +0.05R)	±(1% +0.05R)	±(0.5% +0.05R)
Soldering heat	±(0.5% +0.05R)	±(0.25% +0.05R)	±(0.3% +0.05R)	±(0.3% +0.05R)
Damp heat cycling	±(1.5% +0.05R)	±(0.5% +0.05R)	±(1.5% +0.05R)	±(1.5% +0.05R)
Endurance (1000 hours)	±(1% +0.05R)	±(0.5% +0.05R)	±(1% +0.05R)	±(1% +0.05R)
Body Colouring	Blue	Blue	Green	Light Green
Colour Code	4 band : colours to EIA359-A, width & spacing to EIA RS-196A & IEC Pub.62			
Resistance to Solvents	Permanent marking. No physical or electrical damage or deterioration.			
Ammo Box Quantity	5K pcs	1K or 5K pcs	1K or 5K pcs	1K or 5K pcs

\* Values outside this range can be supplied to special factory order.

**CURRENT NOISE**

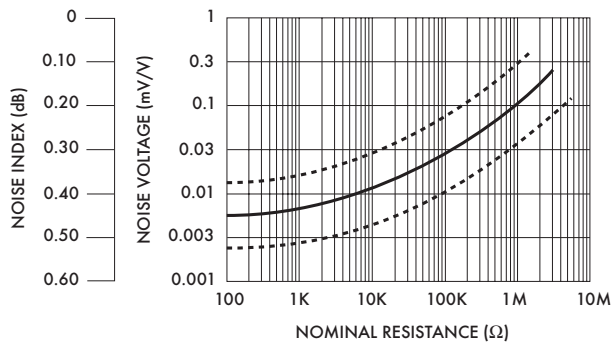

**DERATING CURVE**

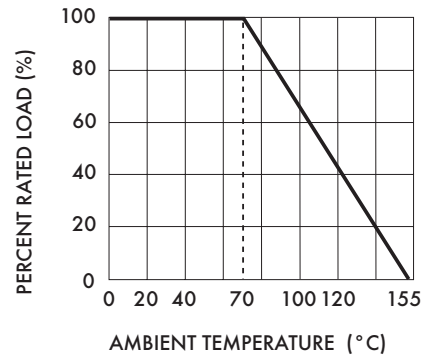

## DIMENSIONS (in mm)

### MCR25/MF25/MF60

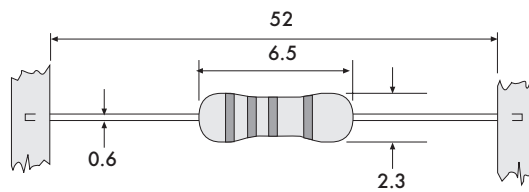

### MF40

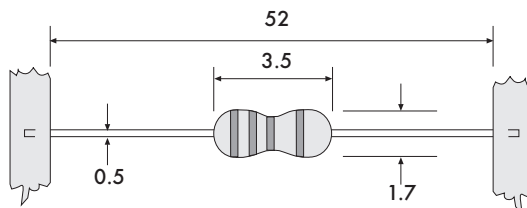

All resistors are delivered on 52mm tape, with a component spacing of 5mm, and packed in ammo boxes. See table for quantity.

A range of fusible resistors of metal film construction. These resistors are designed to offer protection against overloads.



- Features :
- Flame retardant coating
  - Max. power handling 0.33 W
  - Safety component for audio & video circuits
  - 5 band colour code
  - Standard 1/4 W body size
  - Protects power supplies & transistors

SPECIFICATION	FR25
Power Dissipation at 70°C	0.33 W
Resistance Tolerance	± 5%
Resistance Range	1R0 to 1K0 (E24)
Working Voltage	250 V
Overload Voltage	500 V
Temperature Coefficient	±100ppm/°C (±200ppm/°C ≤ 15R)
Operating Temperature Range	-55°C to +155°C
Performance (resistance stability)	
Short term overload	±(1% + 0.05R)
Temperature cycling	±(2% + 0.05R)
Soldering heat	±(1% + 0.05R)
Damp heat cycling	±(5% + 0.05R)
Endurance (1000 hours)	±(5% + 0.05R)
Colour Code	5 band : colours to EIA359-A, width & spacing to EIA RS-196A & IEC Pub.62
Resistance to Solvents	Permanent marking. No physical or electrical damage or deterioration.
Body Colour	Red - Brown

OVERLOAD CURVE

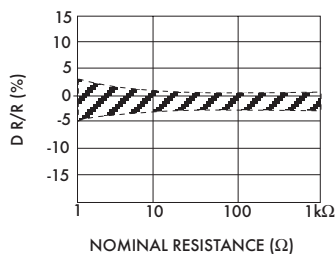

DERATING CURVE

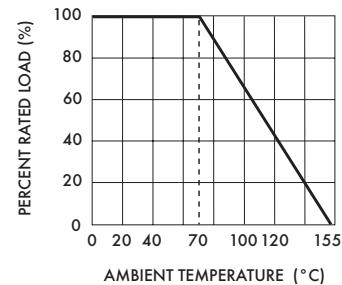

Dimensions (in mm)

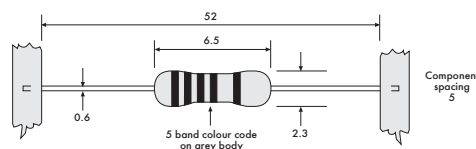



A range of industry standard resistors ideally suited for both industrial and consumer applications.

**Features :**

- Meets MIL-R-11
- 4 band colour code
- Extended power handling on lower ratings
- Offers good all round performance at low cost

SPECIFICATION	CR16	CR25	CR50S	CR100	CR200
Power Dissipation at 70 °C	0.2W	0.33W	0.66W	1W	2W
Resistance Tolerance	±5%	±5%	±5%	±5%	±5%
Resistance Range	10R to 1M0 (E24)	1R0 to 10M (E24)	1R0 to 10M (E24)	1R0 to 10M (E12)	1R0 to 10M (E12)
Working Voltage	200V	250V	350V	500V	500V
Overload Voltage	400V	500V	700V	1000V	1000V
Temperature Coefficient	0 to -1000ppm/°C				
Operating Temperature Range	-55 °C to +155 °C				
Current Noise	<0.5µV/V for values up to 100K <1.0µV/V on higher values				
Performance					
Short term overload	±(0.5% +0.05R)				
Vibration	±(0.5% +0.05R)				
Temperature cycling	±(0.5% +0.05R)				
Soldering heat	±(0.5% +0.05R)				
Damp heat cycling	±(3% +0.05R)				
Endurance (1000 hours)	±(3% +0.05R)				
Body Colouring	Light Brown				
Colour Code	4 band : colours to EIA359-A, width & spacing to EIA RS-196A & IEC Pub.62				
Resistance to Solvents	Permanent marking. No physical or electrical damage or deterioration.				
Ammo Box Quantity	5K pcs	1K or 5K pcs	4K pcs	1K pcs	1K pcs

### TEMPERATURE COEFFICIENT

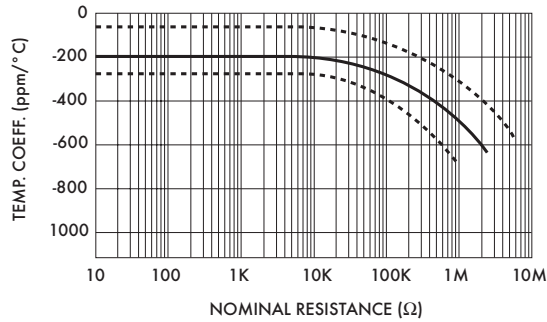

### CURRENT NOISE

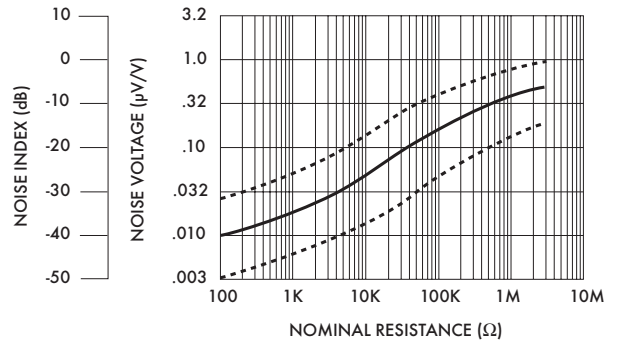

### DERATING CURVE

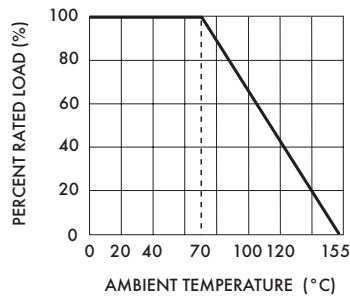

### DIMENSIONS (in mm)

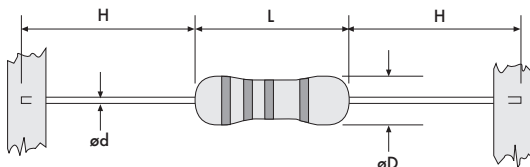

Type	L	øD	H	ød
CR16	3.2±0.2	1.7±0.2	28.0±3	0.5±0.05
CR25	6.5±0.5	2.3±0.3	28.0±3	0.6±0.05
CR50S	8.5±0.5	2.8±0.5	28.0±3	0.6±0.05
CR100	11.0±1	4.0±0.5	26.0±3	0.8±0.05
CR200	15.0±1	5.0±0.5	24.0±3	0.8±0.05

All resistors are supplied on 52mm tape, with a component spacing of 5mm (2W : 10mm), and packed in ammo boxes (standard) or on reels.

A range of axial lead wirewound resistors manufactured to a high level of specification yet offered at very competitive pricing. Rated 2.5W at 70°C and 3.0W at 40°C.

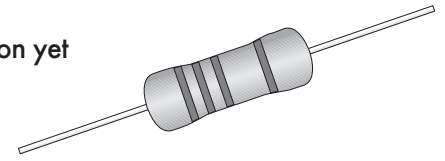

**Features:**

- 2.5W/3.0W rating
- Rugged construction
- Flame retardant coating
- Low cost
- 4 band colour code
- Available loose or taped

SPECIFICATION	WR250
Power Dissipation	2.5 Watt at 70°C 3.0 Watt at 40°C
Resistance Tolerance	±5%
Resistance Range	0R1 to 270R (E12)
Temperature Coefficient	±300ppm/°C (values ≥ 22R) ±400ppm/°C (values < 22R)
Operating Temperature Range	-40°C to +200°C
Performance (resistance stability)	
Short term overload	±(2% + 0.05R)
Vibration	±(1% + 0.05R)
Temperature cycling	±(1% + 0.05R)
Soldering heat	±(1% + 0.05R)
Damp heat cycling	±(5% + 0.05R)
Endurance (1000 hours)	±(5% + 0.05R)
Colour Code	4 band : colours to EIA359-A, width & spacing to EIA RS-196A & IEC Pub.62
Resistance to Solvents	Permanent marking. No physical or electrical damage or deterioration.
Body Colour	Grey or Green

### SURFACE TEMPERATURE RISE

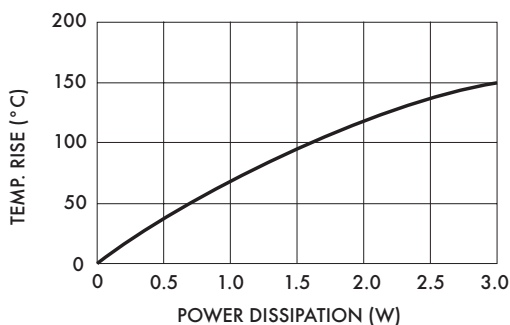

### DERATING CURVE

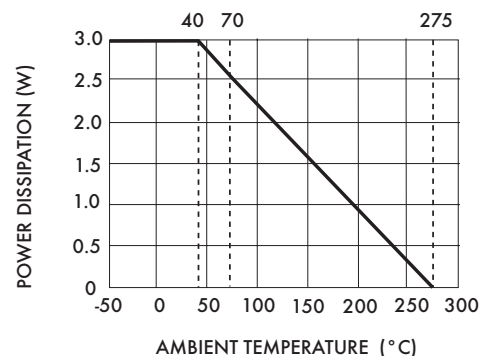

### DIMENSIONS (in mm)

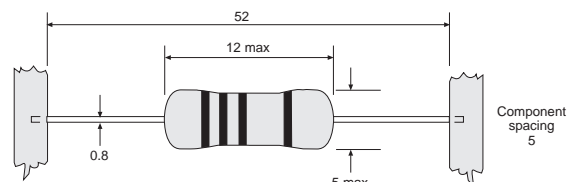
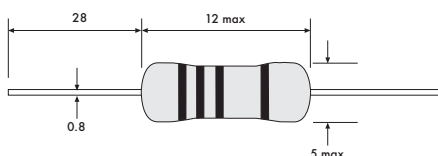

A range of high power metal oxide resistors with excellent performance. Offers high surge and overload capability and temperature stability.



**Features:**

- Meets MIL-R-11
  - 3W power rating
  - Flame proof coating
  - Non-inductive design
- 5 % tolerance, 4 band colour code
  - Excellent temperature coefficient
  - High surge and overload capability
  - Low cost and high safety standard

SPECIFICATION	MX 300
Power Dissipation at 70 °C	3W
Resistance Tolerance	± 5%
Resistance Range	1R0 to 1M0 (E12)
Working Voltage	500 V
Overload Voltage	1000 V
Temperature Coefficient	±50ppm/°C typ., ±150ppm/°C max.
Operating Temperature Range	-55 °C to + 200 °C
Current Noise	0.1 μV/V (values ≤ 1K) rising to 0.5 μV/V on highest values
Insulation Resistance	10,000 MΩ min.
Performance (resistance stability)	
Short term overload	±(0.5 % max)
Temperature cycling	±(1.0 % max)
Soldering heat	±(0.5 % max)
Damp heat cycling	±(2.0 % max)
Endurance (1000 hours)	±(3.0 % max)
Vibration	±(0.2 % max)
Colour Code	4 band : colours to EIA359-A, width & spacing to EIA RS-196A & IEC Pub.62
Resistance to Solvents	Permanent marking. No physical or electrical damage or deterioration.
Body Colour	Grey

**DERATING CURVE**

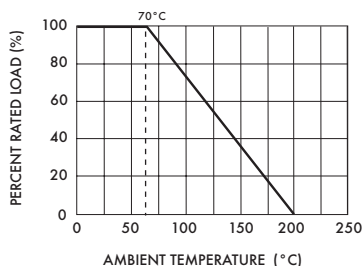

**SURFACE TEMPERATURE RISE**

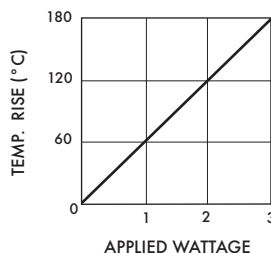

**DIMENSIONS (mm)**

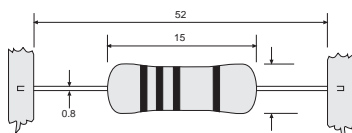

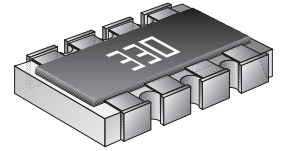

A range of thick film, chip resistor arrays housed in the industry standard 1206 package. The arrays consist of four isolated resistors and are of a reliable monolithic construction. Supplied taped and reeled in quantities of 5K pcs.

**Features:**

- Convex or Concave terminals
- Low noise
- Topside marking for easy identification
- Small size and light weight
- Suitable for both Re-flow and Wave soldering
- High reliability and stability

SPECIFICATION	RCN16
Power Dissipation at 70 °C	0.063W (per resistor) 0.25W (per package)
Resistance Tolerance	±5% (J)
Resistance Range	10R to 1MΩ (E12)
Temperature Coefficient	±250ppm/°C
Operating Temperature Range	-55 °C to +125 °C
Maximum Working Voltage	50V
Maximum Overload Voltage	100V
Performance (resistance stability)	
Short term overload	±(3% +0.1R)
Vibration	±(1% +0.1R)
Temperature cycling	±(2% +0.1R)
Soldering heat	±(1% +0.1R)
Damp heat cycling	±(3% +0.1R)
Endurance (1000 hours)	±(3% +0.1R)
Resistance to Solvents	Permanent marking. No physical or

### DERATING CURVE

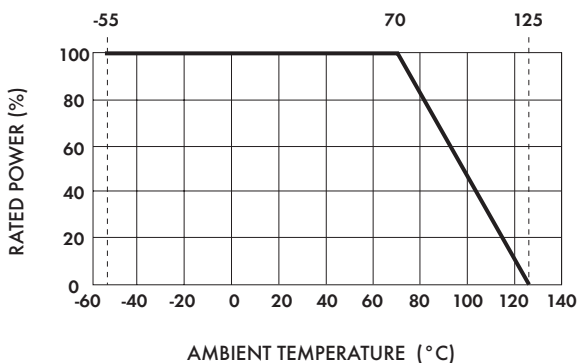

### CIRCUIT

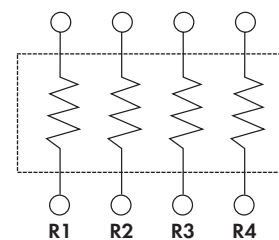

### DIMENSIONS (mm)

#### CONVEX (suffix 4)

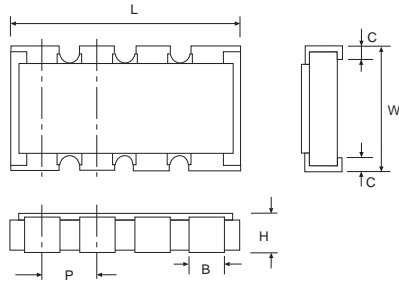

L	W	H	P	B	C
3.2 ± 0.1	1.6 ± 0.1	0.5 ± 0.1	0.8 ± 0.05	0.65 ± 0.1	0.25 ± 0.1

#### CONCAVE (suffix 04)

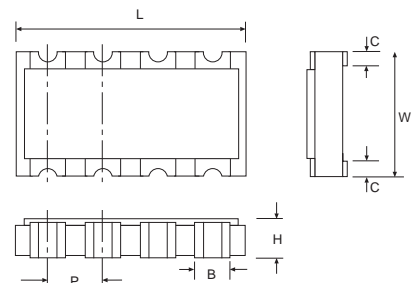

L	W	H	P	B	C
3.2 ± 0.2	1.6 ± 0.15	0.6 ± 0.1	0.8 ± 0.15	0.5 ± 0.1	0.40 ± 0.2

### CONSTRUCTION

#### CONVEX

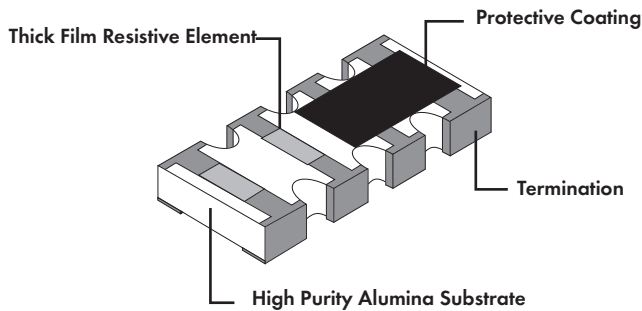

#### CONCAVE

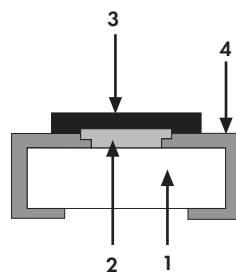
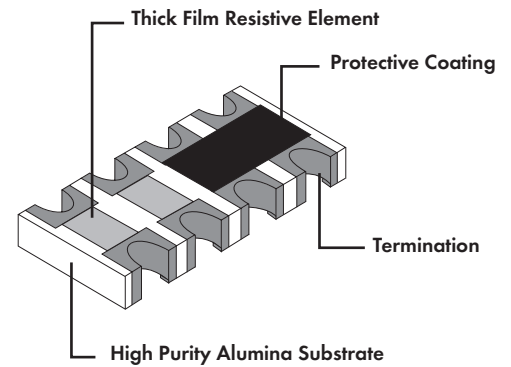

1. High Purity Alumina Substrate
2. Thick Film Resistive Element
3. Protective Coating
4. Termination

### PACKAGING

#### TAPE (Paper)

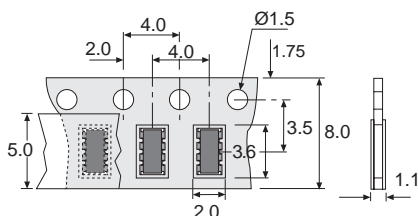

#### REELS (Plastic)

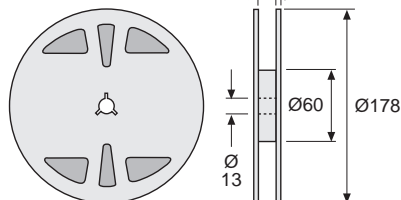

### MARKING

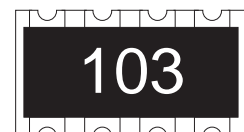

Each resistor is marked with a three digit code to designate the nominal resistance value. The first and second digits are significant, and the third denotes the number of zeros.

e.g 103 denotes 10K $\Omega$